



# BEDIENINGSINSTRUCTIE

2024-02

# 1.0 BEDIENINGSINSTRUCTIE VOOR RAMEN

## 1.1 DRAAI

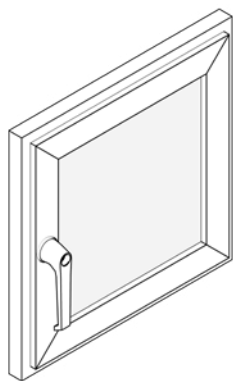

A – Dicht

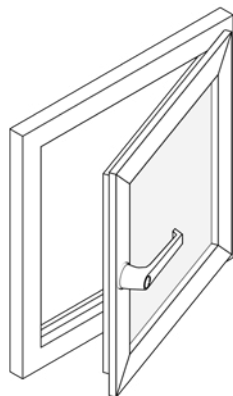

B – Open

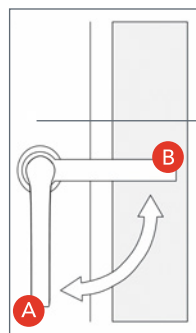

(Optioneel)

## 1.2 DRAAI-KIEP

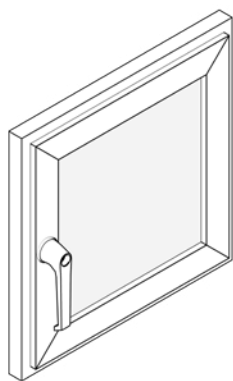

A – Dicht

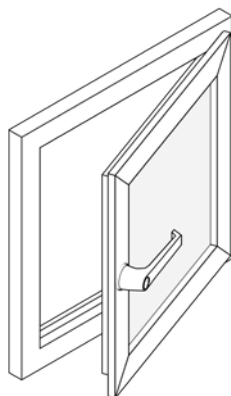

B – Open  
(draaistand)

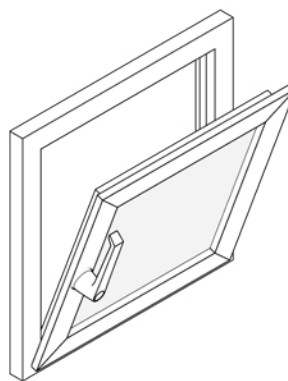

C – Open  
(kiepstand voor ventileren)



(Optioneel)

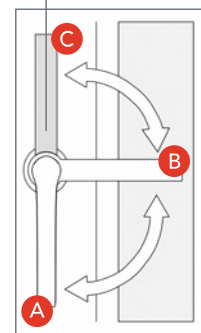

## 1.3 KIEP-VOOR-DRAAI

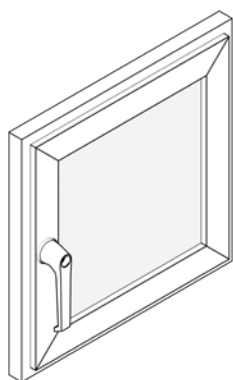

A – Dicht

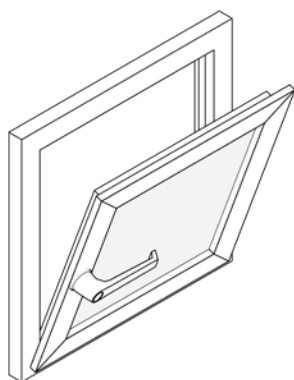

B – Open  
(kiepstand voor ventileren)

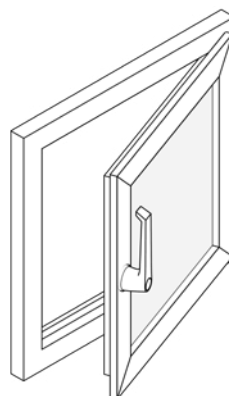

C – Open  
(draaistand)



(Optioneel)

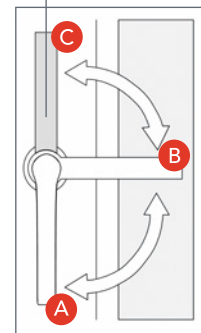

# 1.0 BEDIENINGSINSTRUCTIE VOOR RAMEN

## 1.4 DUBBELE RAMEN

### 1.4.1 ESPAGNOLETSLUITING

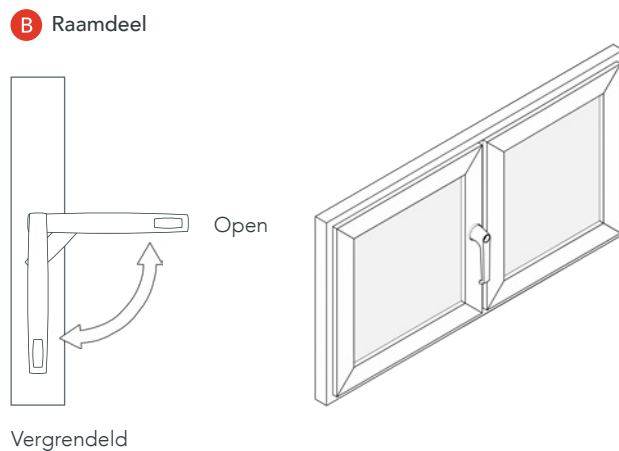
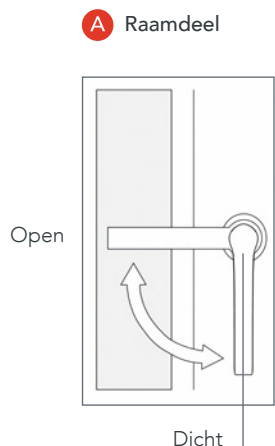
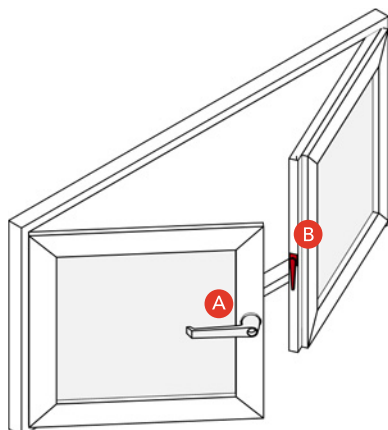

(Optioneel)

Let op! Eerst raamdeel **B** sluiten en vergrendelen alvorens raamdeel **A** te sluiten

### 1.4.2 SCHUIFVERGRENDELING

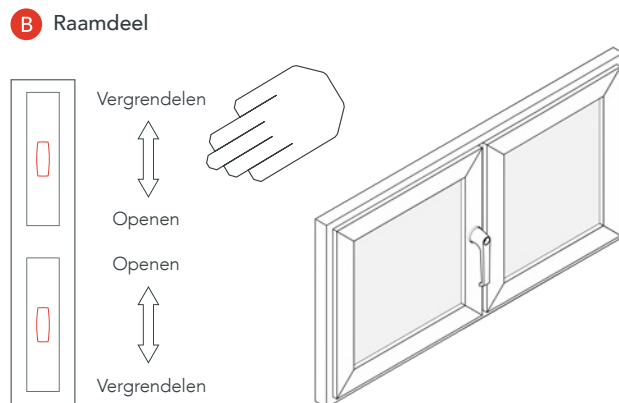
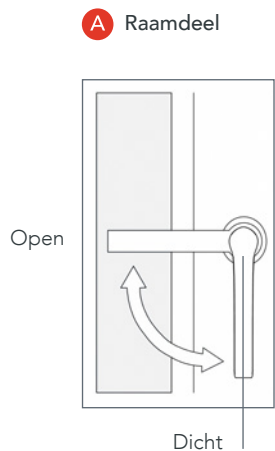
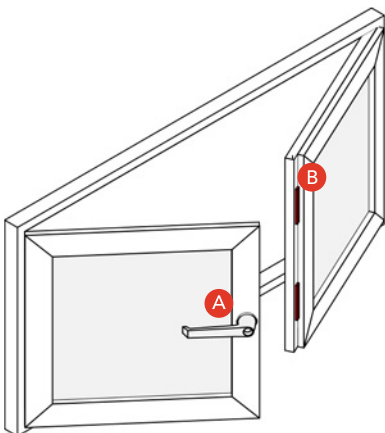

(Optioneel)

Let op! Eerst raamdeel **B** sluiten en vergrendelen alvorens raamdeel **A** te sluiten

# 1.0 BEDIENINGSINSTRUCTIE VOOR RAMEN

## 1.4.3 KRUKVERGREDELING

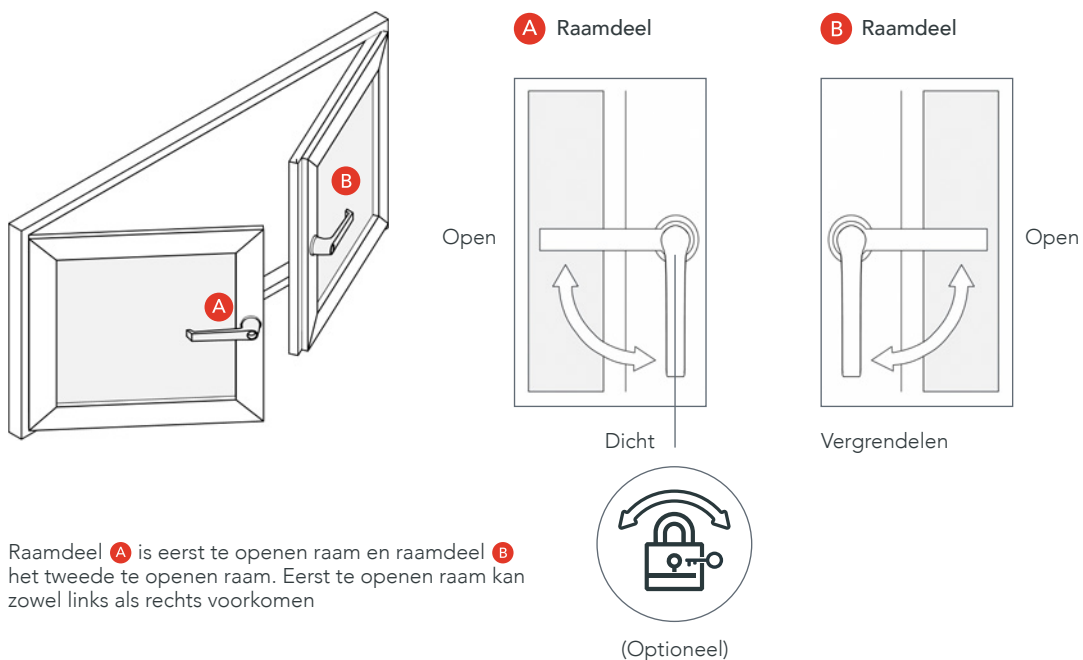

## 1.4.4 OPTIE – DUBBELE RAMEN MET DRAAI-KIEP FUNCTIE

Optioneel kan het eerst te openen raam uitgevoerd zijn met een draai-kiep functie, of kiep-voor-draai functie. Zie 1.2 en 1.3 voor de de bediening

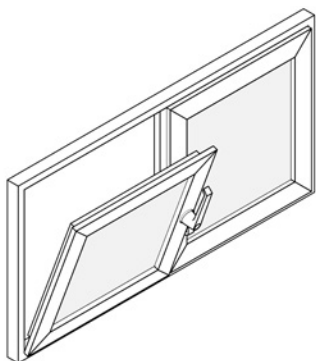

# 1.0 BEDIENINGSINSTRUCTIE VOOR RAMEN

## 1.5 VERGREDELING MET DRAAIBLOKKERING

Zowel enkele als dubbele ramen met kiep-voor-draai functie kunnen optioneel uitgevoerd zijn met een vergrendeling met draaiblokkering.

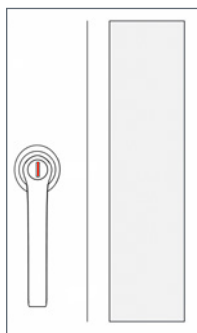

Dicht

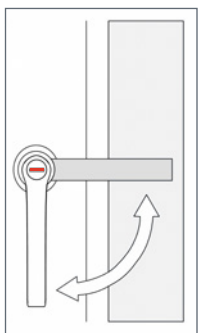

Kiepstand voor ventileren  
Draaistand geblokkeerd  
(sleutel uit te nemen)

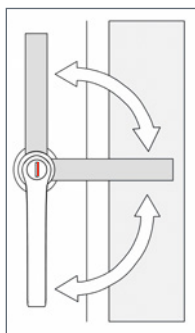

Kiep- of draaistand  
na volledig ronddraaien sleutel

## 1.6 TUIMELRAAM

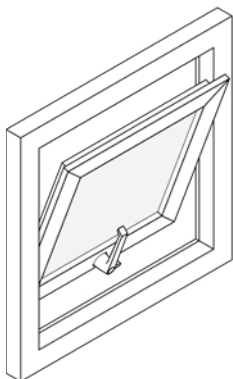

Open

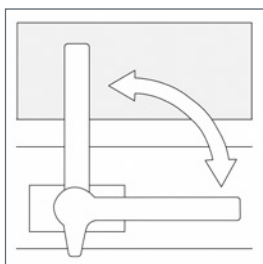

Dicht



(Optioneel)

# 2.0 BEDIENINGSINSTRUCTIES VOOR DEUREN

## 2.1 STANDAARD DEUREN

### 2.1.1 ENKELE DEUR

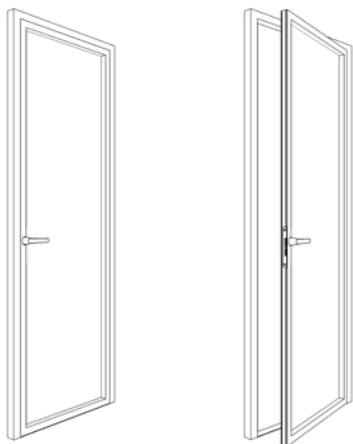

#### Krukbediend



#### Sleutelbediend



### 2.1.2 DUBBELE DEUR

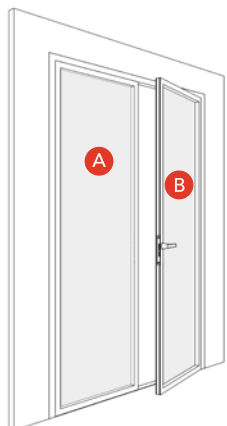

**A** Espagnoletsluiting passieve deur

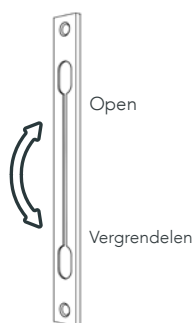

**B** Bediening actieve deur

#### Krukbediend

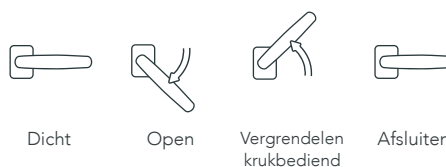

#### Sleutelbediend



**Let op!** Vergrendel altijd eerst de deur zonder greep **A** voordat de deur met greep **B** gesloten wordt. Dit om beschadiging en ongewenste toegang te voorkomen.

# 2.0 BEDIENINGSINSTRUCTIES VOOR DEUREN

## 2.2 SCHUIFDEUREN

### 2.2.1 HEF-SCHUIFDEUR/-PUI

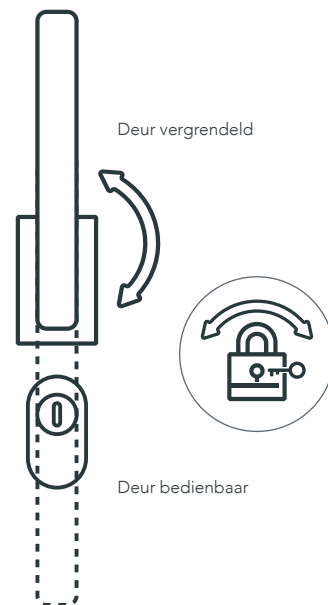
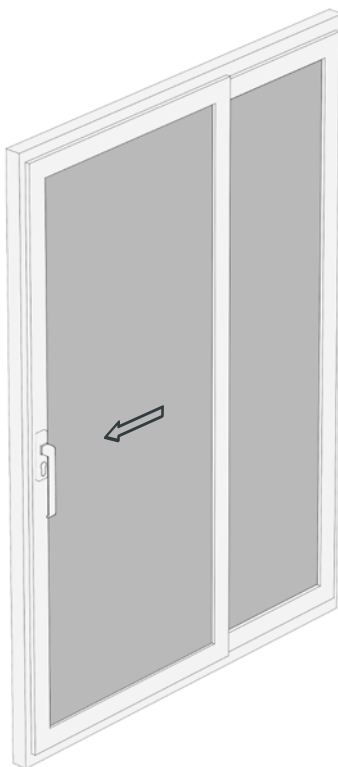
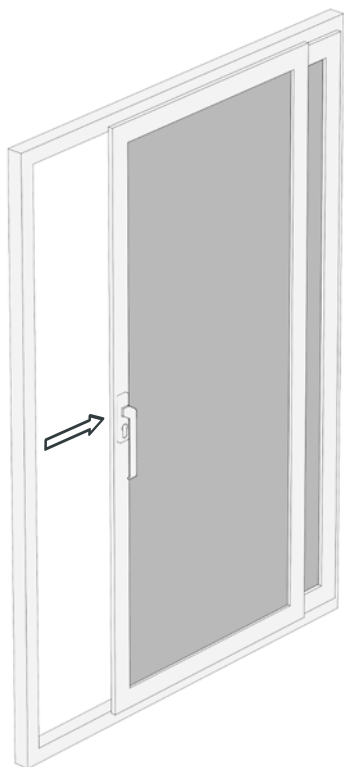

## 2.2 SCHUIFDEUREN

### 2.2.1 STANDAARD SCHUIFDEUR/-PUI

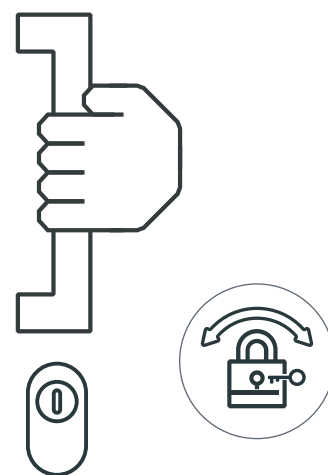
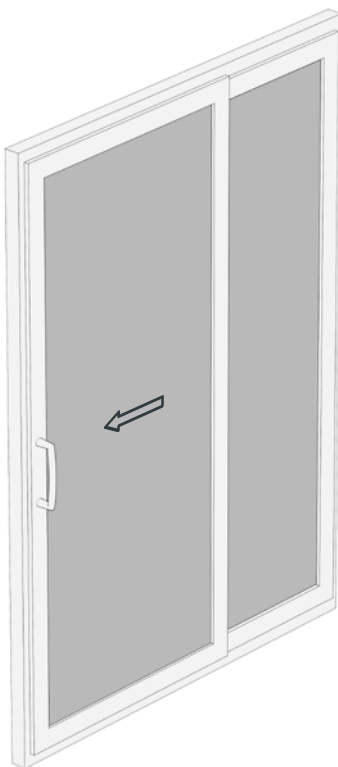
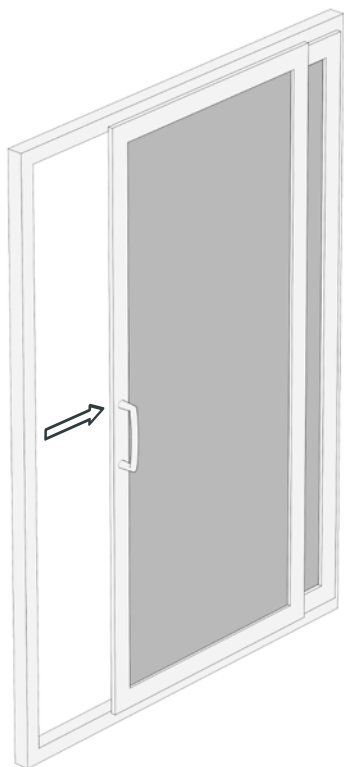

---

KAWNEER

Archimedesstraat 9  
3846 CT Harderwijk  
Nederland

Postbus 391  
3840 AJ Harderwijk  
Nederland

[www.kawneer.nl](http://www.kawneer.nl)  
+31 (0)341 46 46 11  
[kawneer.benelux@arconic.com](mailto:kawneer.benelux@arconic.com)

Building  
Legacies

